

- Static power consumption: <1 W
- Output current: <4 A (each channel)
- Output power: 5 V: <60W, 12V: <144W, 24V: <288W

Controller External Dimension:

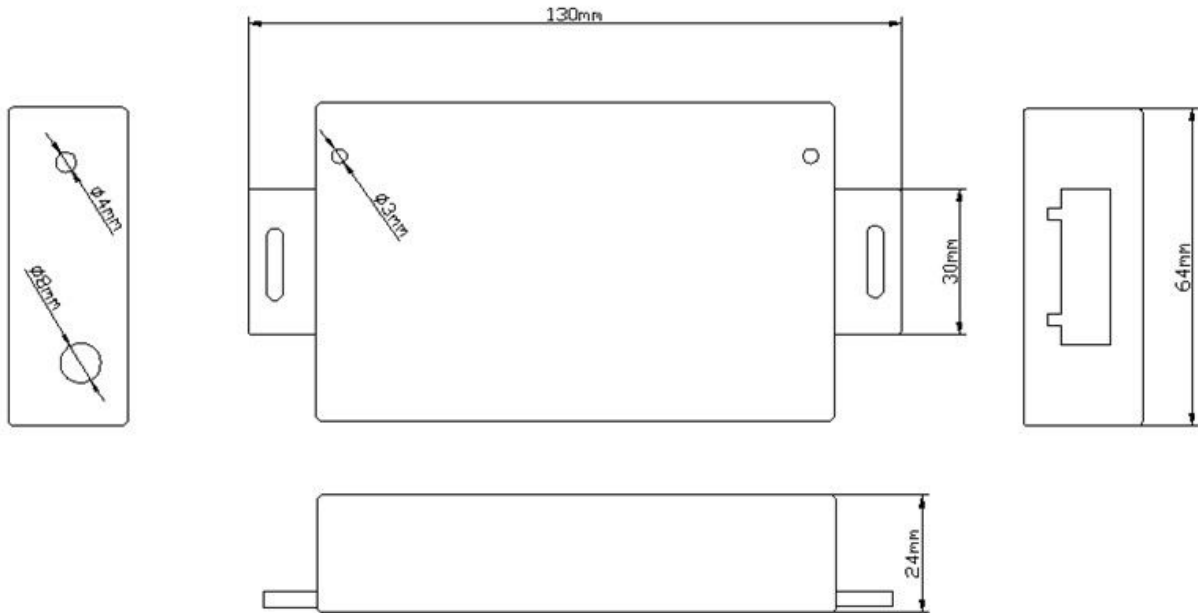

Remote Control External Dimension:

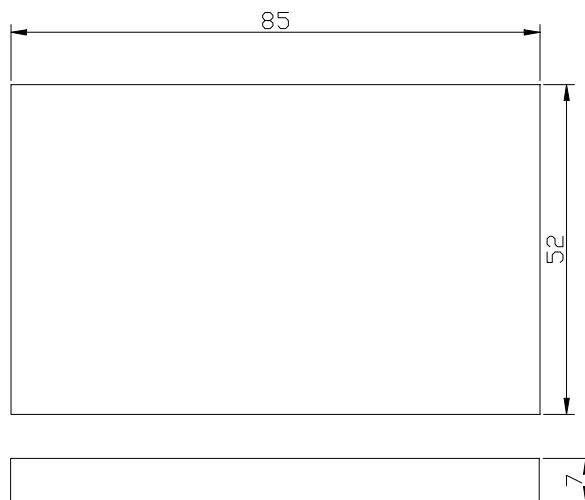

Interface Specifications

Power input interface (the first way):



Adopt conventional DC power Transposon as power input interface, and equip with plug-DC

Power input interface (the second way):



Adopt male and female connector with screw.



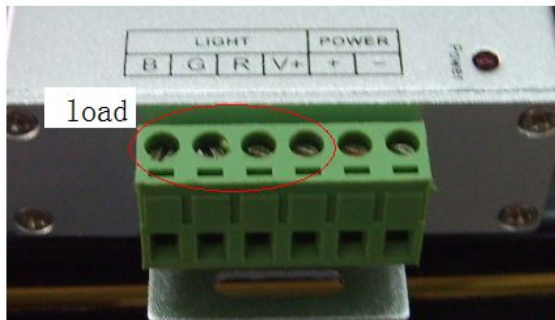

Load output interface:



Adopt male and female connector with screw.

Direction for use

1. Connect the load wire at first, following by the power wire; **Please ensure short circuit can not occur between connecting wire before you turn on the power;**
2. Standard change functions are as follows:

| Button | Button description | remarks |
|-----------------------------------------------------------------------------------|------------------------------|--------------------------------------------------------------|
|  | ON/OFF | you could turn on or turn off the output of controller |
|  | Play/Stop | Play or stop led changing, easy to observe led static effect |
|  | Brightness increase | the brightness series will add once you press it |
|  | Brightness decrease | The brightness series will reduce once you press it |
| RED | Static red | Brightness is adjustable,Speed is unadjustable. |
| GREEN | Static Green | |
| BLUE | Static Blue | |
| WHITE | Static white | |
| ORANGE | Static Orange | |
| YELLOW | Static Yellow | |
| CYAN | Static cyan | |
| PURPLE | Static Pink | |
| AUTO | Automation | Moving all the modles automationly |
| JUMP3 | 3 Color step change | Speed and brightness are adjustable |
| FADE3 | 3 Color fade change | Speed is adjustable,brightness is unadjustable |
| SPEED+ | Speed increase | The speed will add once when you press it. |
| FLASH | Seven colors flash frequency | Speed and brightness are adjustable |
| JUMP7 | 7 Color step change | |
| FADE7 | 7 Color fade change | Speed is adjustable,brightness is unadjustable |
| SPEED- | Speed decrease | The speed series will reduce once when you press it |

Specification of coding wireless remote control: When power on, close to the controller, at the same time press the ON/OFF key of remote control, long press this key in 3s to match code. The load light will flicker after match code success.

Typical Applications

Applications one :

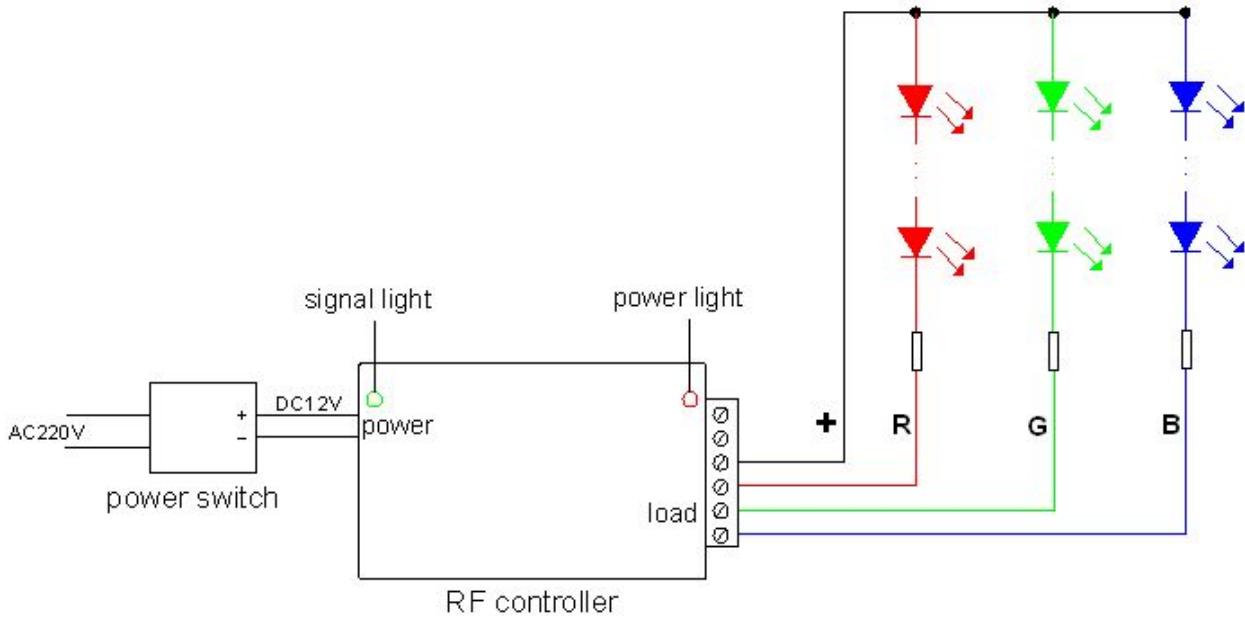

Applications two :

